

1200V 75mΩ Silicon Carbide Power MOSFET

Features

- AEC-Q101 qualified
- High blocking voltage with low on-resistance
- High switching speed with low capacitance
- Very fast and robust intrinsic body diode with low reverse recovery
- Very low switching losses
- Excellent avalanche ruggedness
- RoHS compliant



Benefits

- Greater system efficiency
- Reduced cooling requirements
- Increased power density
- Increased system switching frequency
- Easy to parallel and simple to drive

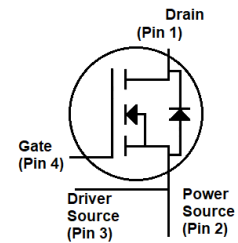

Potential Applications

- Solar inverters
- Uninterrupted power supplies
- Switch mode power supplies
- Motor drives

Package Type: TO-247-4L



Description

The Sanan Semiconductor 1200V/75mΩ silicon carbide power MOSFET uses advanced SiC MOSFET technology with low on-resistance, low switching losses, and a high operation temperature of 175°C. It is suitable for use in high frequency circuits and provides a reduction in overall system size, increased efficiency and increased switching frequency. It has been widely used in applications including solar inverters, uninterrupted power supplies, switch mode power supplies, and motor drives. Using RoHS compliant components and being AEC-Q101 qualified, it is qualified for use in industrial application.

Product Specifications

Device	V _{DS}	I _D (25°C)	R _{(DS)on}	Marking
AMS1200075M	1200V	41A	75mΩ	MS1200075M

CONTENTS

Features.....	1
Benefits.....	1
Potential Applications.....	1
Description.....	1
Product Specifications	1
Table 1 Maximum Ratings	3
Table 2 Thermal Resistances.....	3
Table 3 Static Electrical Characteristics.....	4
Table 4 Dynamic Electrical Characteristics	4
Table 5 Switching Characteristics	5
Table 6 Reverse SiC Diode Characteristics	6
Electrical Characteristic Diagrams.....	7
Package Information	15
Recommended Solder Pad Layout.....	16
Ordering Information	16
Important Notices – Read Carefully	17
Warning	17

Table 1. Maximum Ratings

(T_C = 25°C, unless otherwise specified)

Parameter	Symbol	Value	Unit	Test conditions
Drain-source voltage	V _{DSmax}	1200	V	V _{GS} = 0V, I _D = 100μA
Gate-source voltage, max. transient voltage	V _{GSmax}	-10/+22		t _p ≤ 0.5us, D < 1%
Gate-source voltage, max. static voltage	V _{GSmax}	-8/+19		
Gate-source voltage	V _{GSop}	-4/+15		Recommended operation values
Continuous drain current	I _D	41	A	V _{GS} = 15V
		29		V _{GS} = 15V, T _C = 100°C
Pulsed drain current	I _{D(pulse)}	88	A	Pulse width t _p limited by T _{jmax}
Power dissipation	P _{tot}	231	W	
Operating junction temperature	T _j	-55~175	°C	
Storage temperature	T _{stg}	-55~175	°C	
Soldering temperature	T _L	260	°C	1.6mm from case for 10s
Mounting torque	M	0.7	Nm	M3 screw

Table 2. Thermal Resistances

Parameter	Symbol	Values			Unit	Test condition
		Min.	Typ.	Max.		
Thermal resistance from junction to case	R _{th(j-c)}	/	0.60	/	°C/W	
Thermal resistance from junction to ambient	R _{th(j-a)}	/	/	40	°C/W	

Table 3. Static Electrical Characteristics

(T_j = 25°C, unless otherwise specified)

Parameter	Symbol	Values			Unit	Test conditions
		Min.	Typ.	Max.		
Drain-source breakdown voltage	V _{(BR)DSS}	1200	/	/	V	V _{GS} = 0V, I _D = 100μA
Gate threshold voltage	V _{GS(th)}	1.8	2.8	4.0		V _{DS} = V _{GS} , I _D = 5mA
		/	2.0	/		V _{DS} = V _{GS} , I _D = 5mA, T _j = 175°C
Drain-source leakage current	I _{DSS}	/	1	50	μA	V _{DS} = 1200V, V _{GS} = 0V
Gate-source leakage current	I _{GSS}	/	1	250	nA	V _{GS} = 15V, V _{DS} = 0V
Drain-source on-state resistance	R _{DS(on)}	/	75	92	mΩ	V _{GS} = 15V, I _D = 18A
		/	105	/		V _{GS} = 15V, I _D = 18A, T _j = 175°C
Transconductance	g _{fs}	/	13	/	S	V _{DS} = 20V, I _D = 18A
		/	12	/		V _{DS} = 20V, I _D = 18A, T _j = 175°C
Internal gate resistance	R _{g(int)}	/	1.5	/	Ω	f = 1MHz, V _{AC} = 25mV

Table 4. Dynamic Electrical Characteristics

(T_j = 25°C, unless otherwise specified)

Parameter	Symbol	Values			Unit	Test conditions
		Min.	Typ.	Max.		
Input capacitance	C _{iss}	/	1487	/	pF	V _{GS} = 0V, V _{DS} = 1000V, f = 100kHz, V _{AC} = 25mV
Output capacitance	C _{oss}	/	79	/		
Reverse transfer capacitance	C _{rss}	/	0.9	/		
C _{oss} stored energy	E _{oss}	/	44	/	μJ	
Gate to source charge	Q _{GS}	/	18	/	nC	V _{DD} = 800V, V _{GS} = -4/+15V, I _D = 18A, I _{GS} = 1mA
Gate to drain charge	Q _{GD}	/	20	/		
Total gate charge	Q _G	/	58	/		

Table 5. Switching Characteristics

(T_j = 25°C, unless otherwise specified)

Parameter	Symbol	Values			Unit	Test conditions	
		Min.	Typ.	Max.			
Turn-on delay time	t _{d(on)}	/	11	/	ns	V _{DD} = 800V, V _{GS} = -4/+15V, I _D = 20A, R _{G(ext)} = 5.1Ω, L = 110μH	
Rise time	t _r	/	19	/			
Turn-off delay time	t _{d(off)}	/	21	/			
Fall time	t _f	/	15	/			
Turn-on switching energy	E _{on}	/	145	/	μJ		
Turn-off switching energy	E _{off}	/	45	/			
Turn-on delay time	t _{d(on)}	/	9	/	ns		V _{DD} = 800V, V _{GS} = -4/+15V, I _D = 20A, R _{G(ext)} = 5.1Ω, L = 110μH, T _j = 175°C
Rise time	t _r	/	20	/			
Turn-off delay time	t _{d(off)}	/	26	/			
Fall time	t _f	/	15	/			
Turn-on switching energy	E _{on}	/	188	/	μJ		
Turn-off switching energy	E _{off}	/	45	/			

Table 6. Reverse SiC Diode Characteristics

($T_j = 25^\circ\text{C}$, unless otherwise specified)

Parameter	Symbol	Values			Unit	Test conditions
		Min.	Typ.	Max.		
Diode forward voltage	V_{SD}	/	3.6	/	V	$V_{GS} = -4V, I_{SD} = 9A$
		/	3.2	/		$V_{GS} = -4V, I_{SD} = 9A,$ $T_j = 175^\circ\text{C}$
Continuous diode forward current	I_S	/	/	41	A	$V_{GS} = -4V, T_C = 25^\circ\text{C}$
Diode pulse current	$I_{S, pulse}$	/	/	88	A	$V_{GS} = -4V$, pulse width t_p limited by T_{jmax}
Reverse recovery time	t_{rr}	/	12	/	ns	$V_{GS} = -4V, I_{SD} = 20A,$ $V_R = 800V,$ $di_f/dt = 3kA/\mu s$
Reverse recovery charge	Q_{rr}	/	0.24	/	μC	
Peak reverse recovery current	I_{rrm}	/	30	/	A	
Reverse recovery time	t_{rr}	/	20	/	ns	$V_{GS} = -4V, I_{SD} = 20A,$ $V_R = 800V, T_j = 175^\circ\text{C},$ $di_f/dt = 3kA/\mu s$
Reverse recovery charge	Q_{rr}	/	0.5	/	μC	
Peak reverse recovery current	I_{rrm}	/	40	/	A	

Electrical Characteristic Diagrams

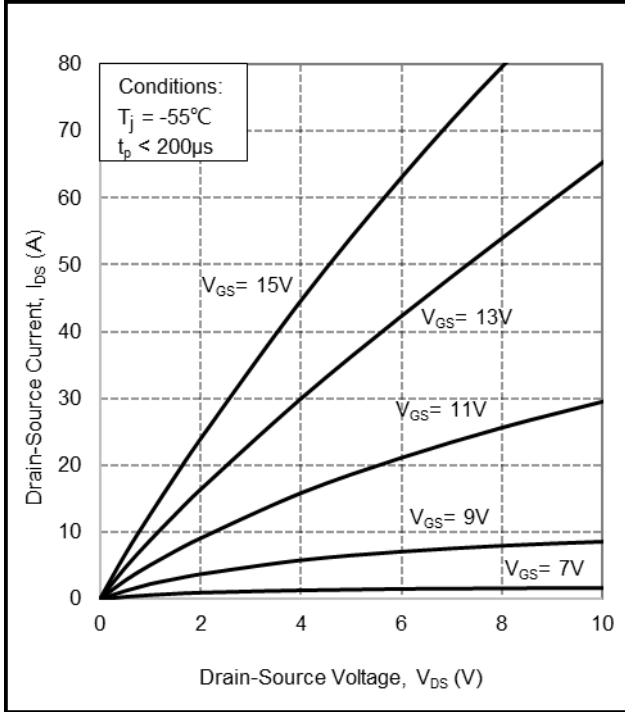

Figure 1. Output characteristics at $T_j = -55^\circ\text{C}$

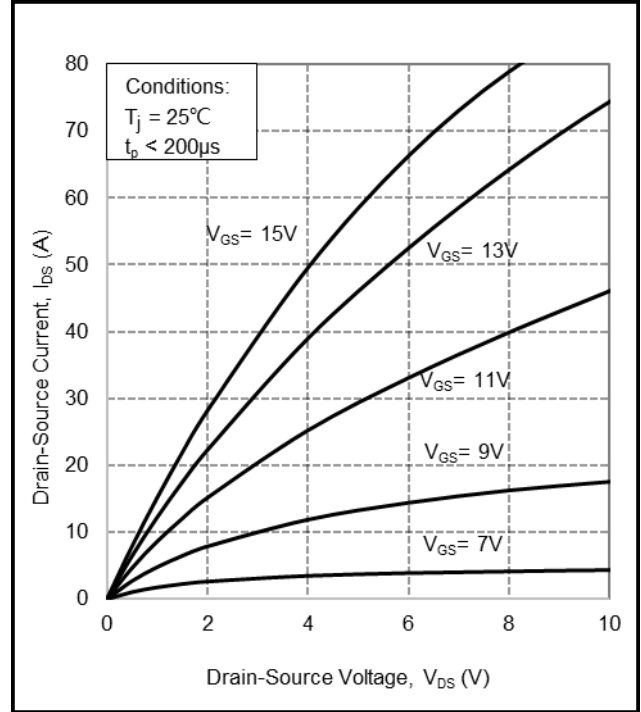

Figure 2. Output characteristics at $T_j = 25^\circ\text{C}$

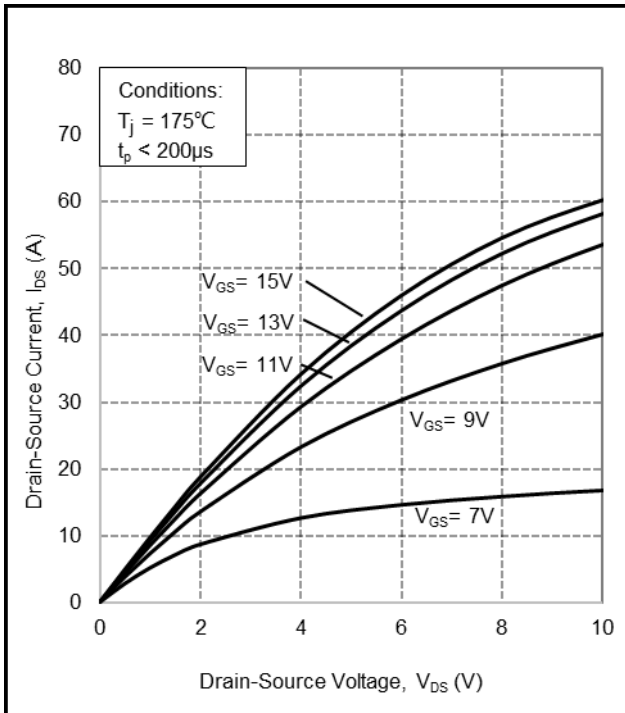

Figure 3. Output characteristics at $T_j = 175^\circ\text{C}$

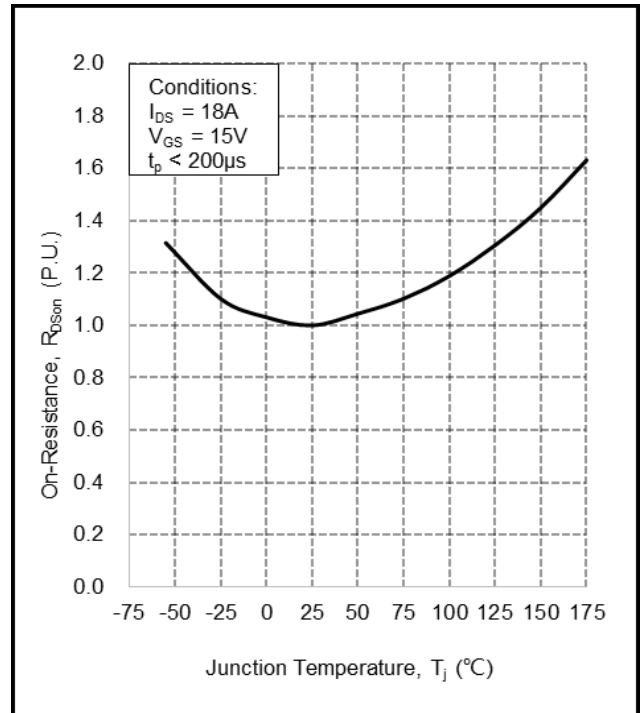

Figure 4. Normalized on-resistance vs. temperature

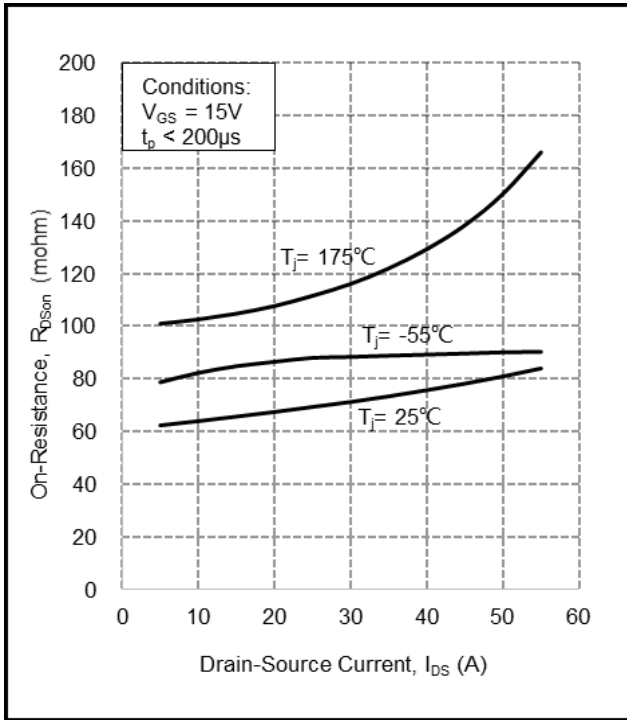

Figure 5. On-resistance vs. drain current for various temperatures

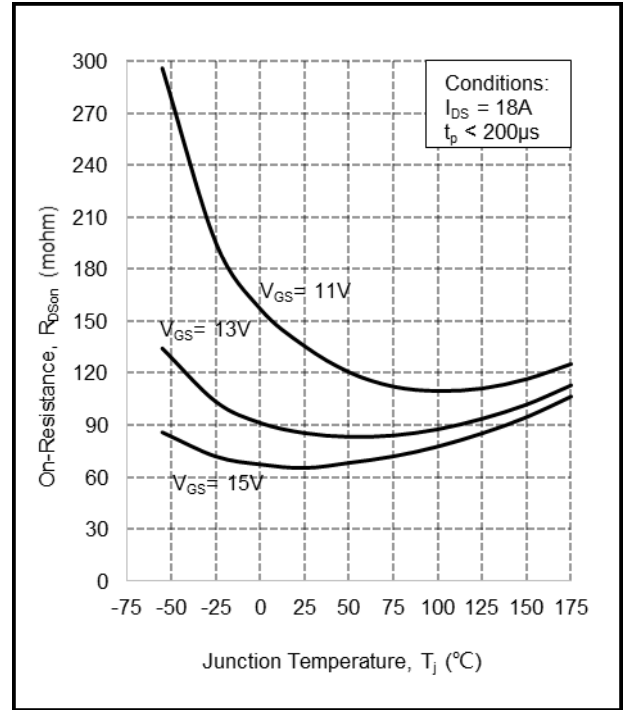

Figure 6. On-resistance vs. temperature for various gate voltages

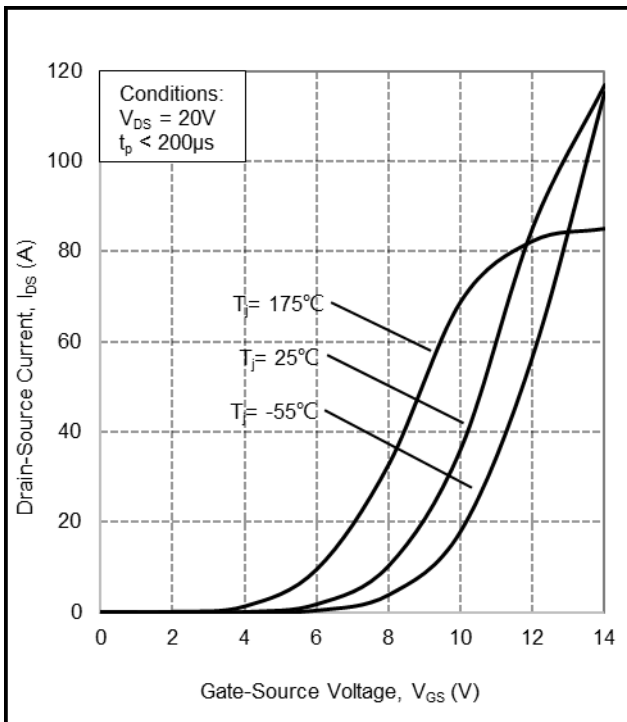

Figure 7. Transfer characteristic for various junction temperatures

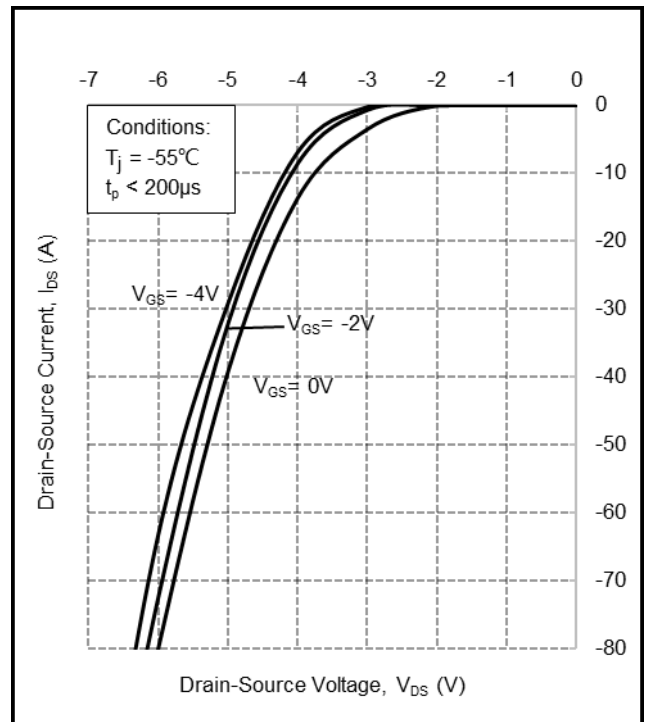

Figure 8. Body diode characteristic at $T_J = -55^\circ\text{C}$

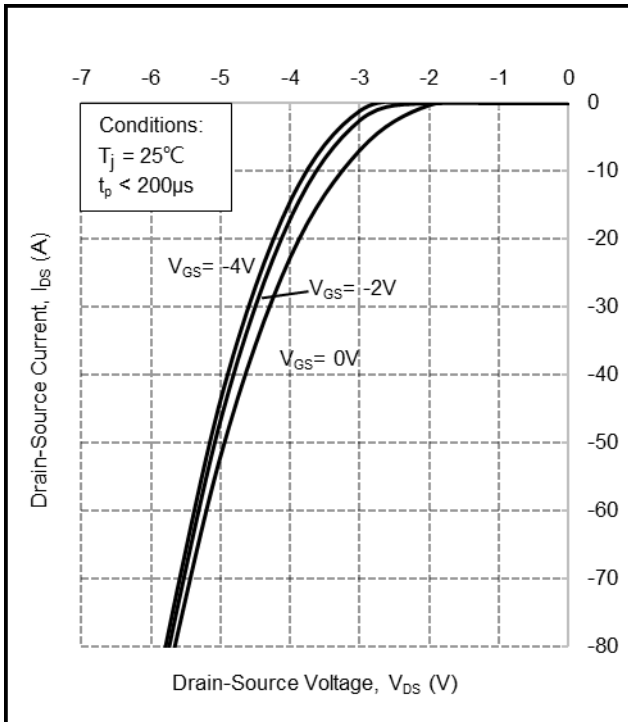

Figure 9. Body diode characteristic at $T_j = 25^\circ\text{C}$

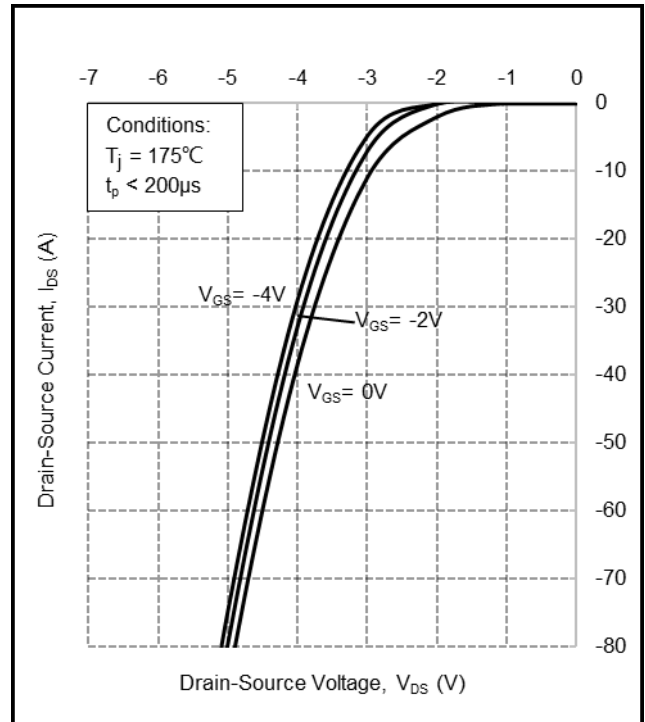

Figure 10. Body diode characteristic at $T_j = 175^\circ\text{C}$

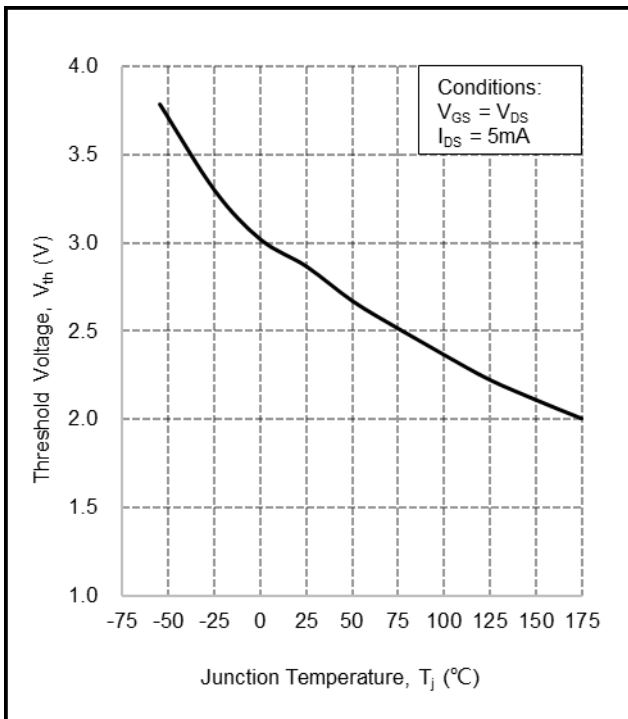

Figure 11. Threshold voltage vs. temperature

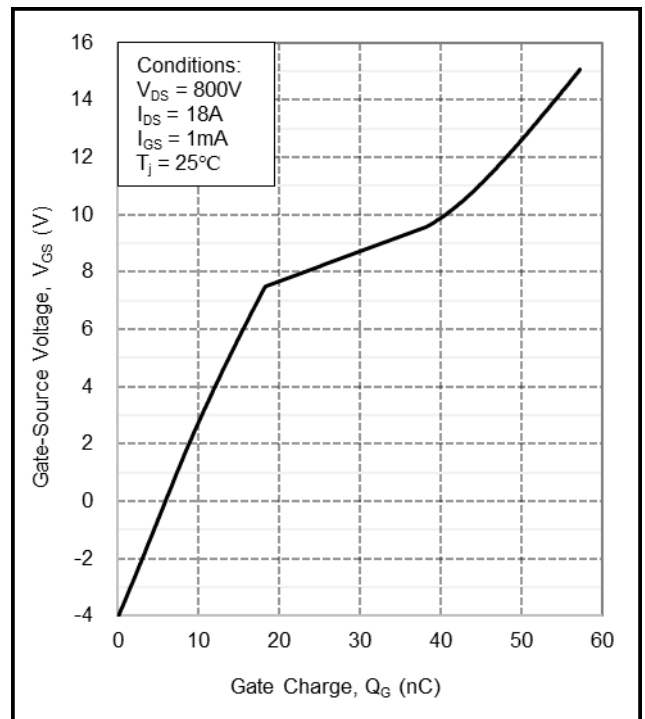

Figure 12. Gate charge characteristics

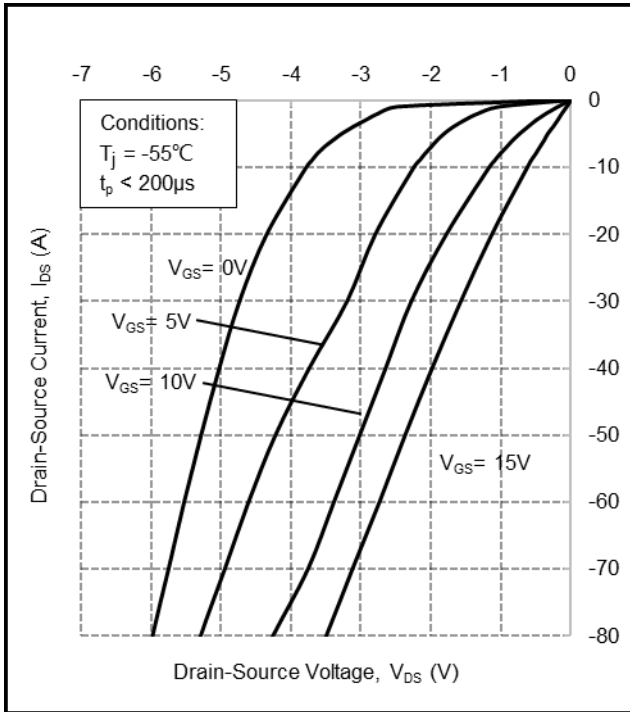

Figure 13. 3rd quadrant characteristic
at $T_j = -55^\circ\text{C}$

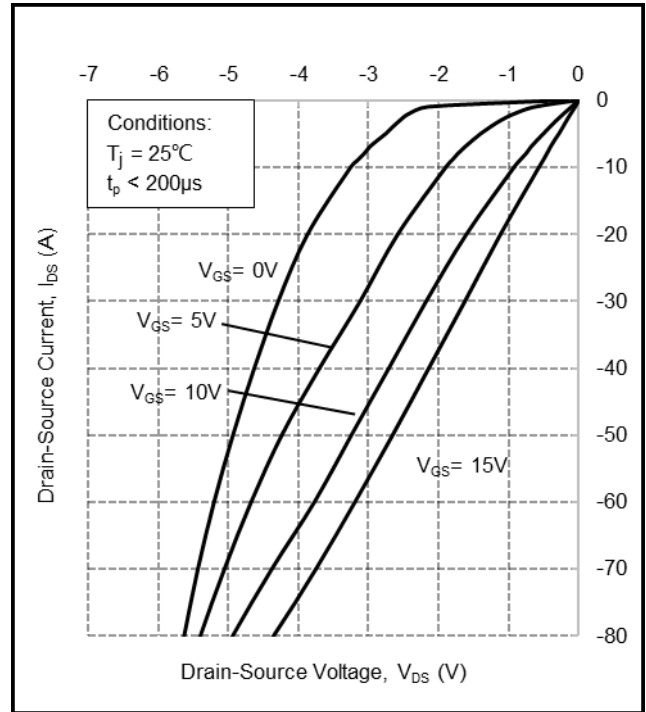

Figure 14. 3rd quadrant characteristic
at $T_j = 25^\circ\text{C}$

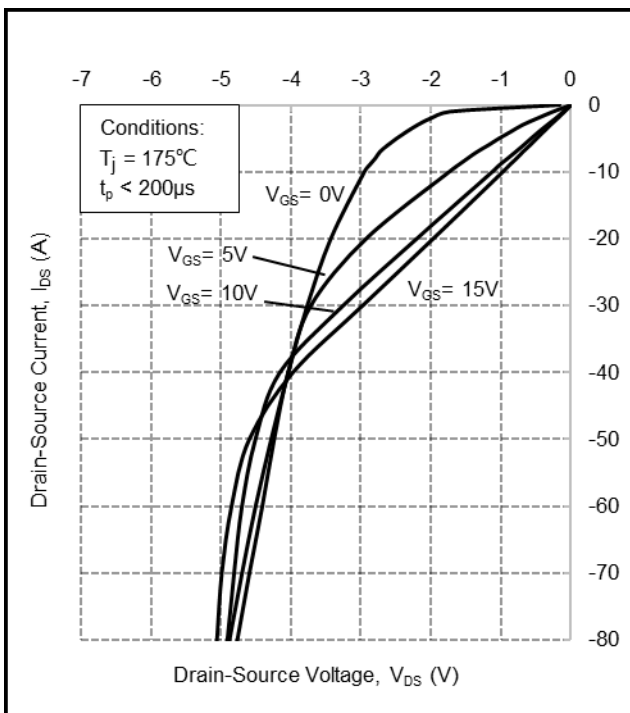

Figure 15. 3rd quadrant characteristic
at $T_j = 175^\circ\text{C}$

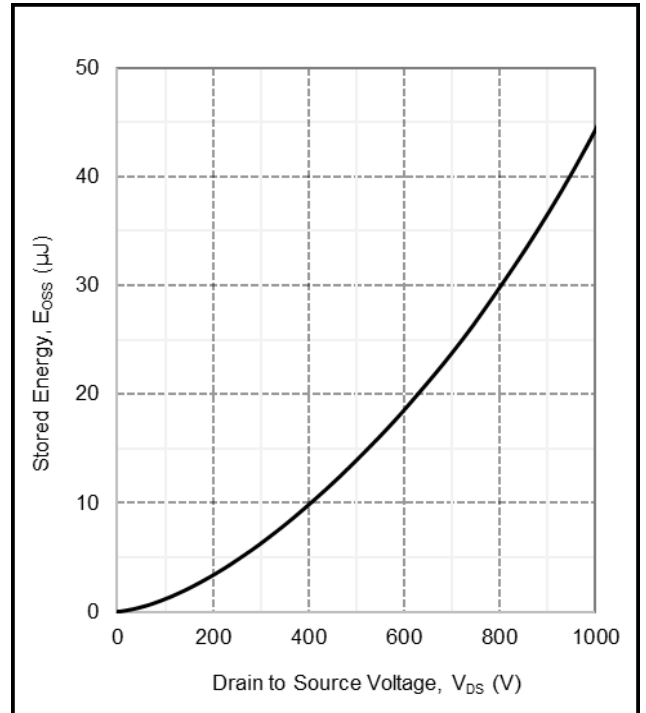

Figure 16. Output capacitor stored energy

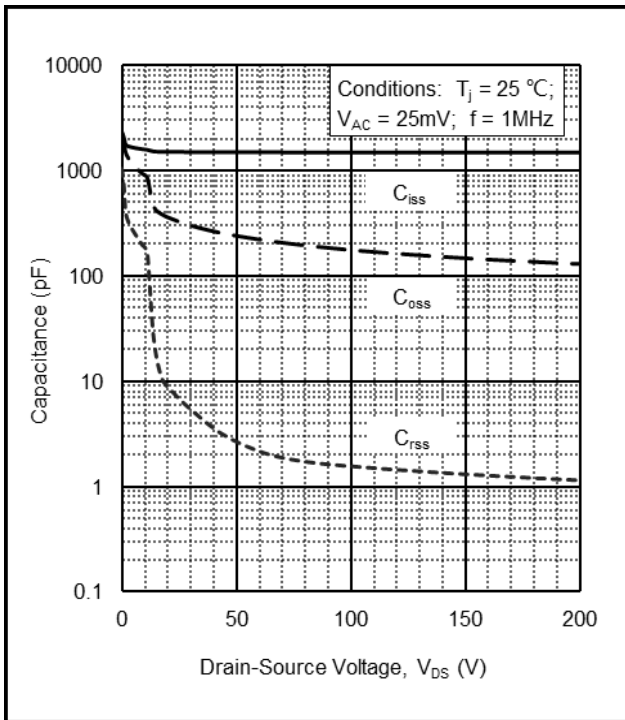

Figure 17. Capacitance vs. drain-source voltage (0 - 200V)

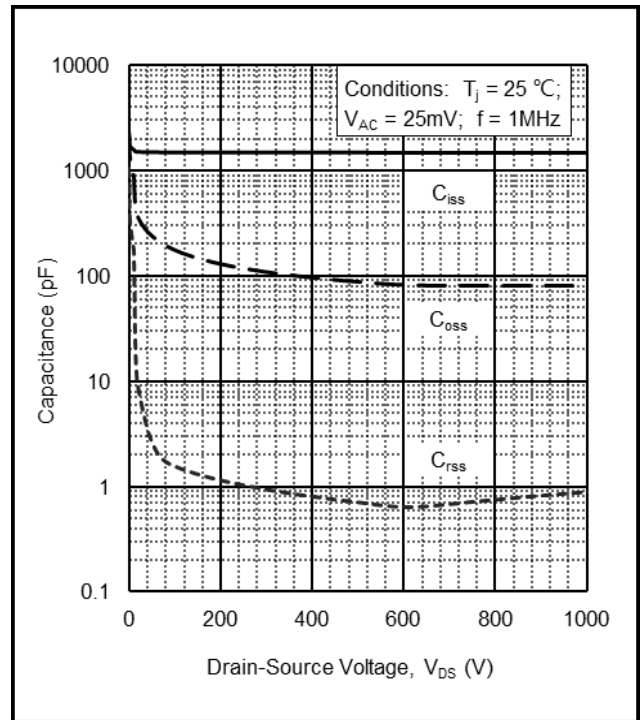

Figure 18. Capacitance vs. drain-source voltage (0 - 1000V)

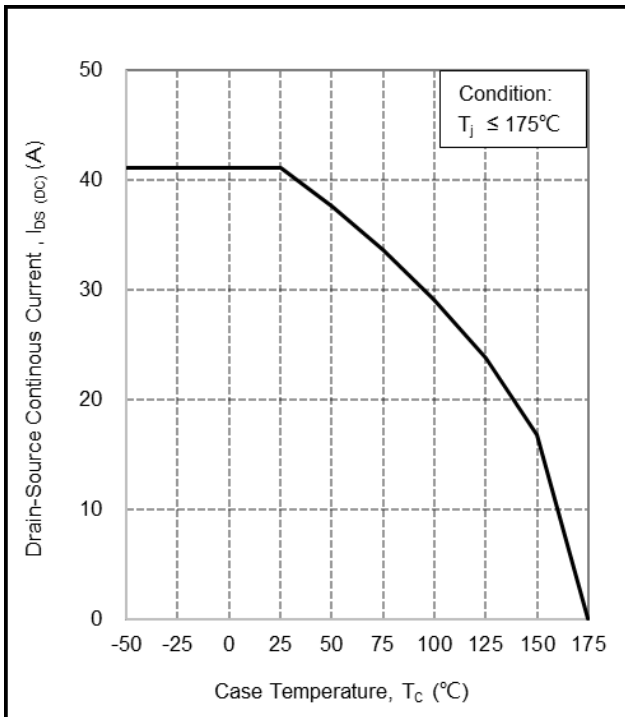

Figure 19. Continuous drain current derating vs. temperature

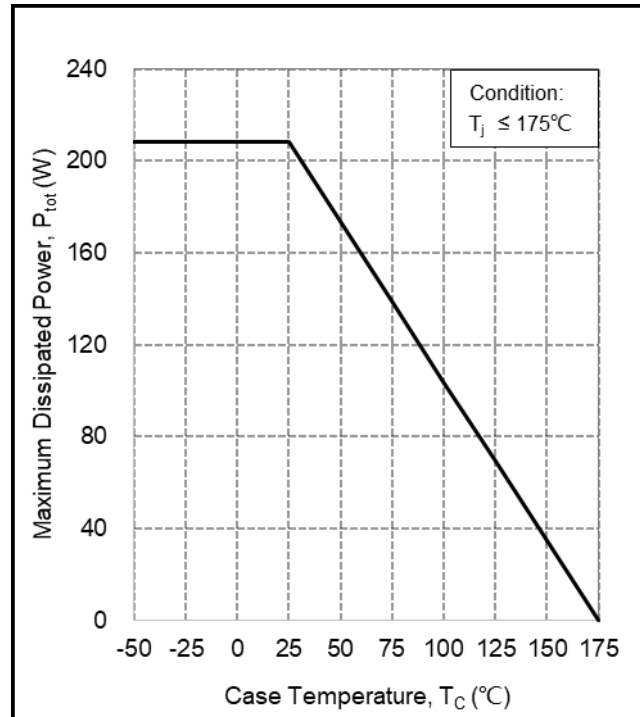

Figure 20. Maximum power dissipation derating vs. temperature

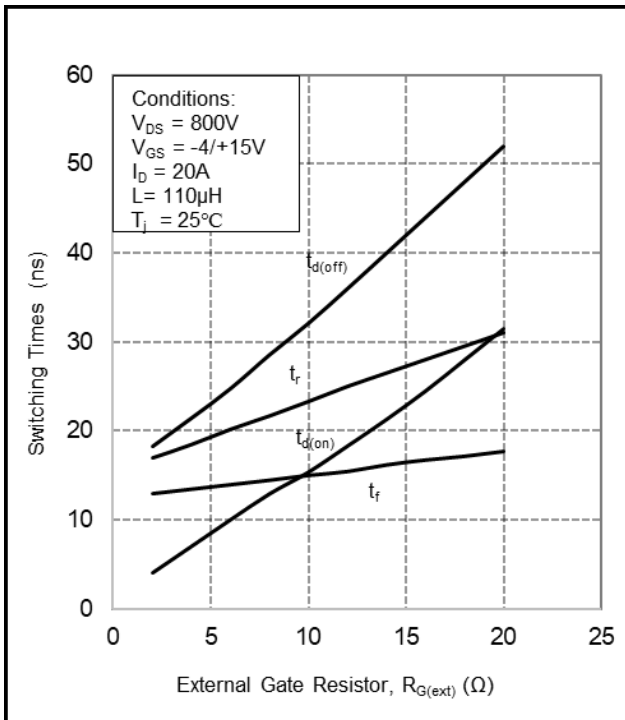

Figure 21. Switching Times vs. $R_{G(ext)}$

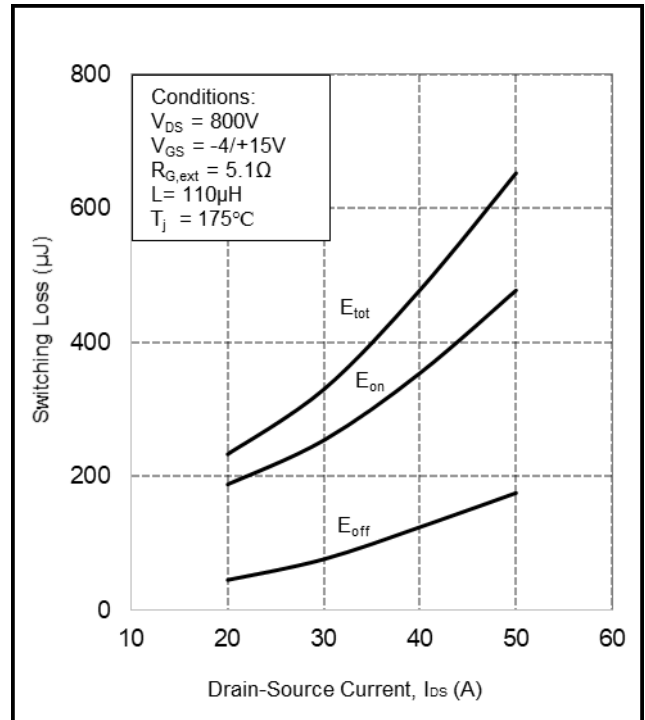

Figure 22. Clamped inductive Switching energy vs. drain current

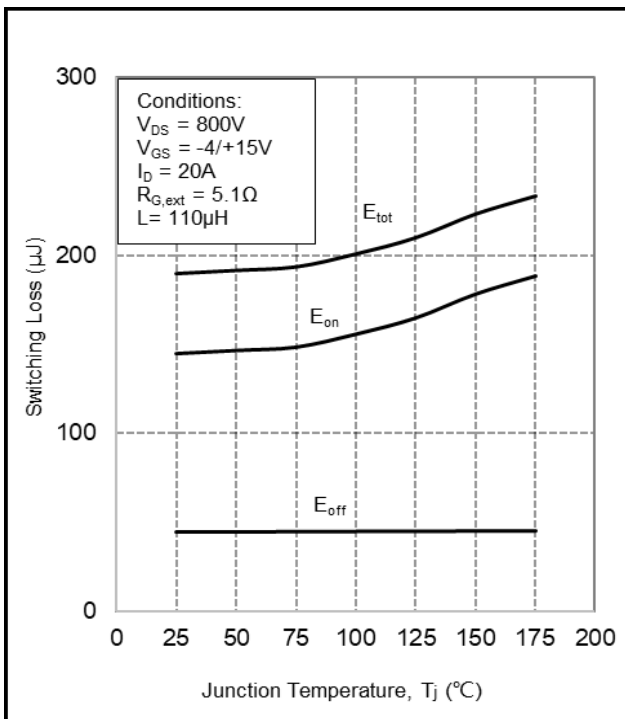

Figure 23. Clamped inductive Switching energy vs. temperature

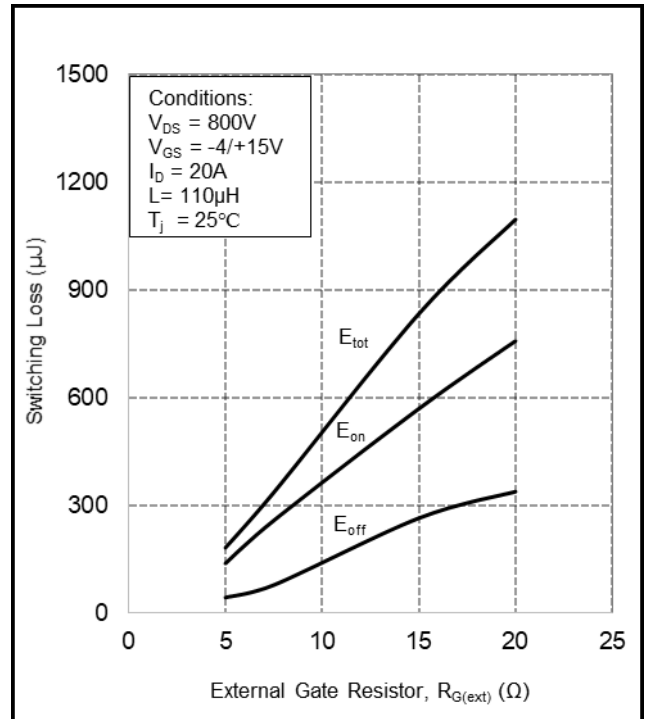

Figure 24. Clamped inductive Switching energy vs. $R_{G(ext)}$

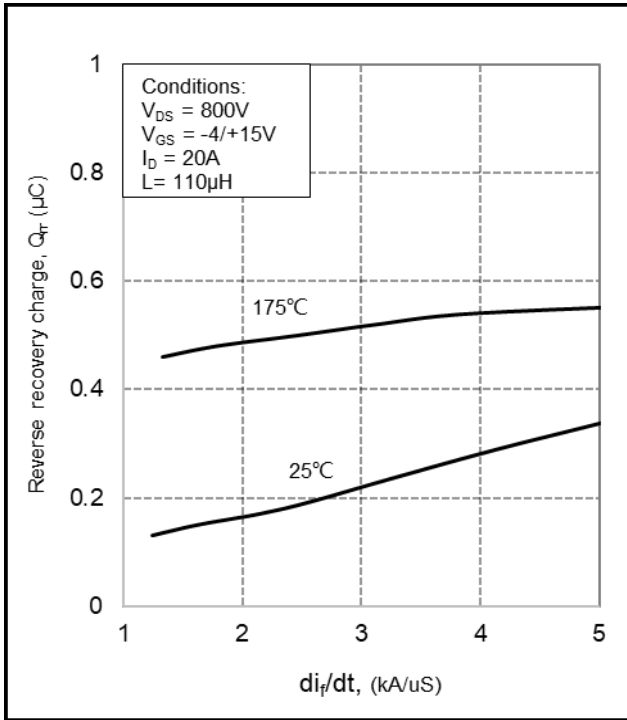

Figure 25. Reverse recovery charge vs. di/dt

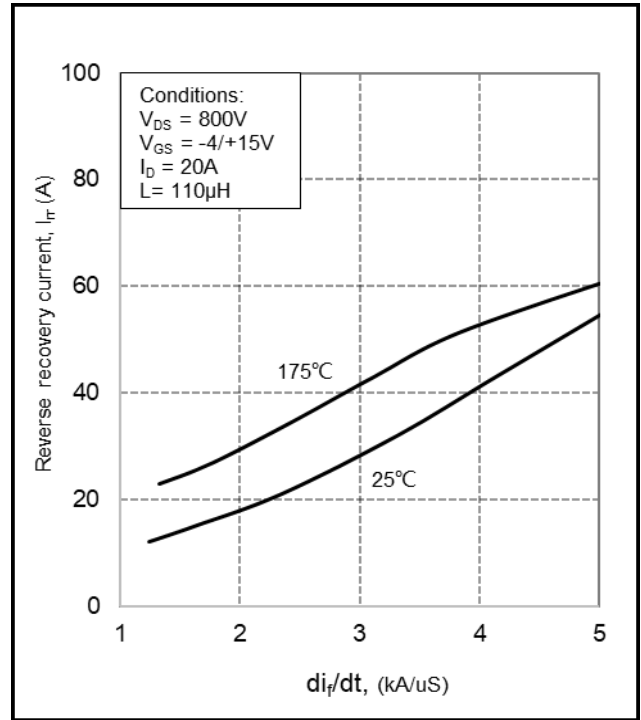

Figure 26. Reverse recovery current vs. di/dt

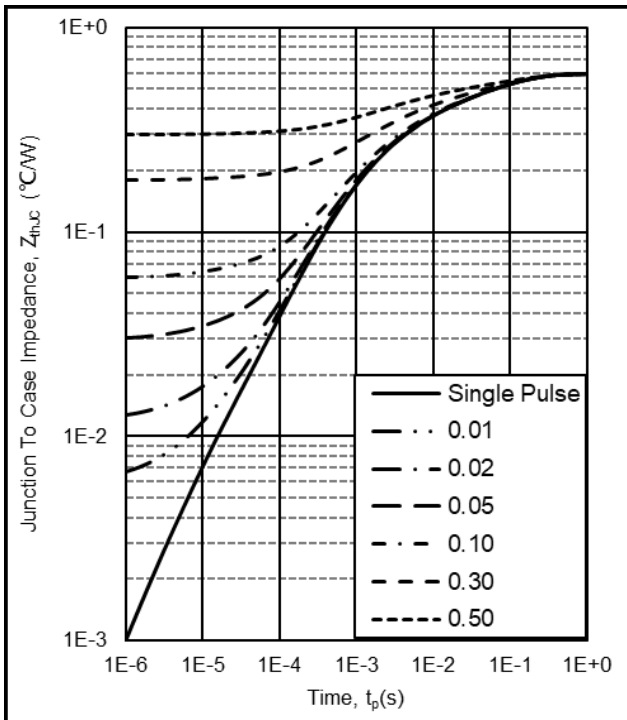

Figure 27. Transient thermal impedance
(Junction - Case)

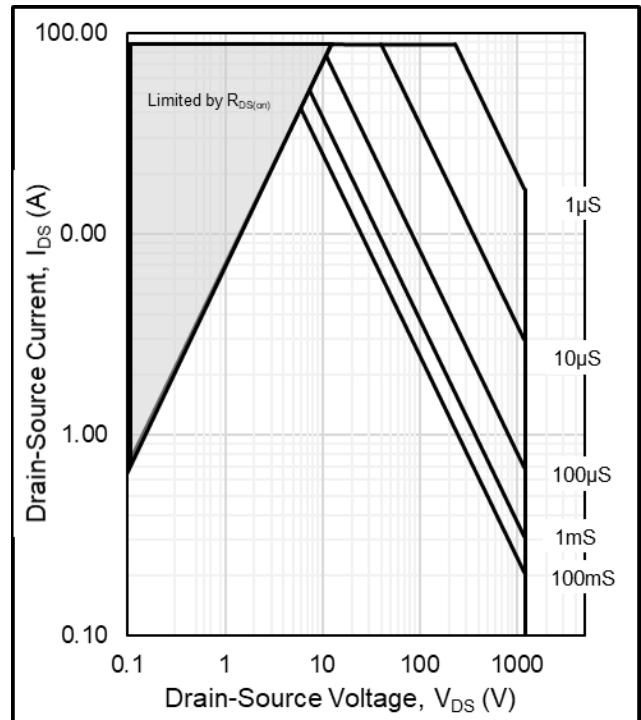

Figure 28. Safe Operating Area

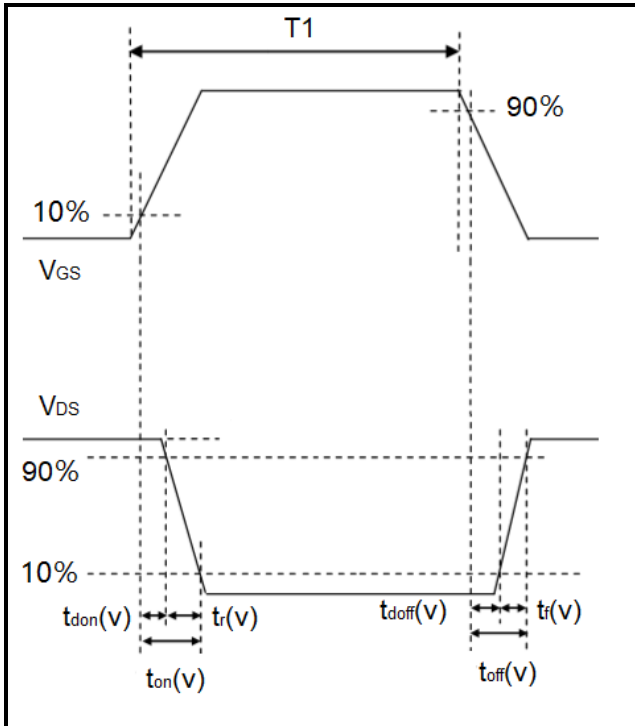

Figure 29. Switching times definition

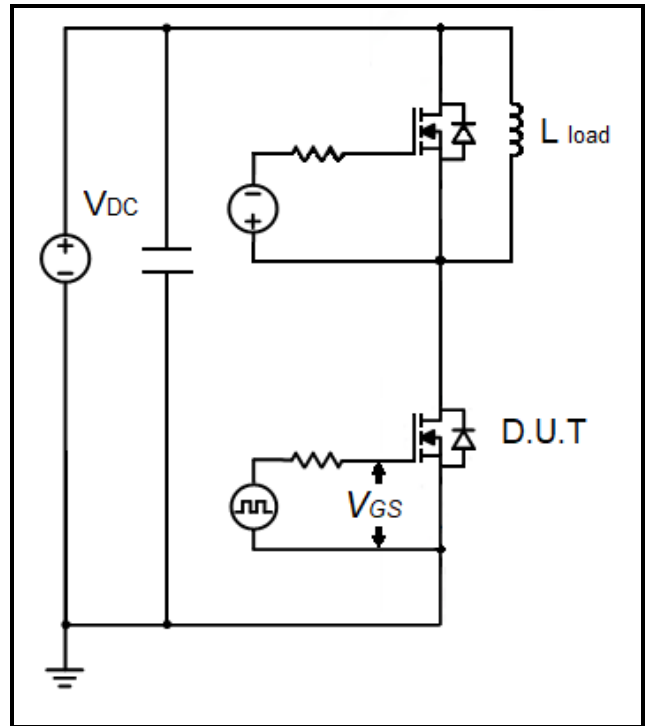
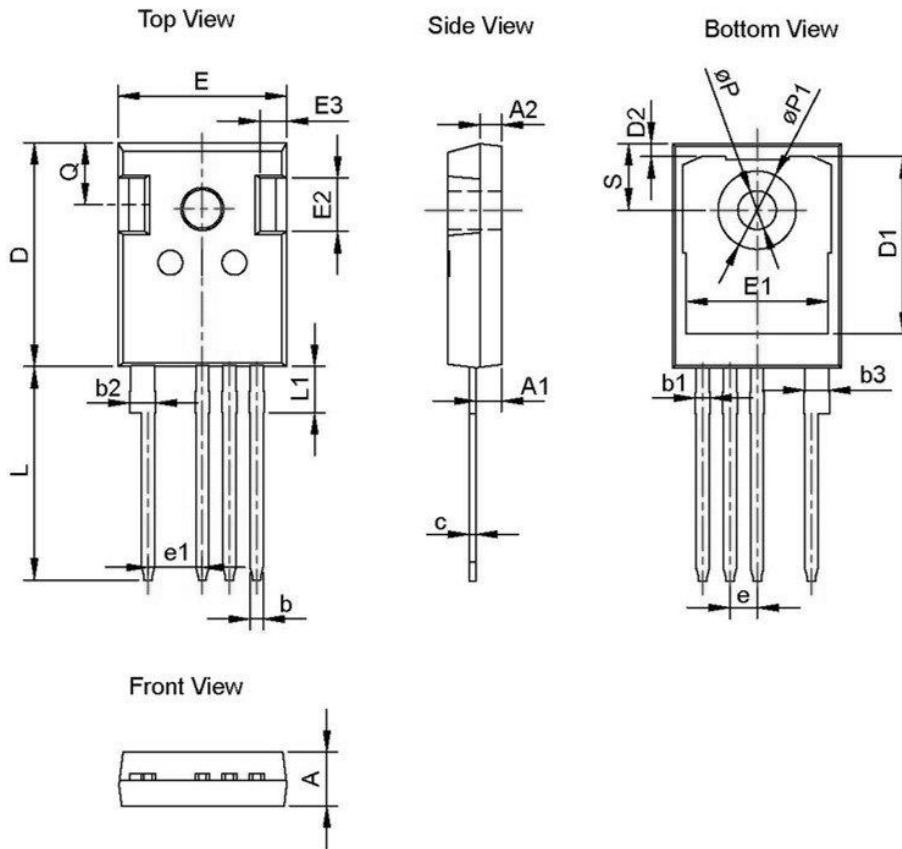

Figure 30. Clamped inductive switching waveform test circuit

Package Information



Dimension unit: [mm]			
Symbol	Min	Nom	Max
A	4.80	5.00	5.20
A1	2.21	2.41	2.61
A2	1.85	2.00	2.15
b	1.11	1.21	1.36
b1	1.11	1.37	1.57
b2	2.24	2.40	2.60
b3	2.11	2.21	2.36
c	0.51	0.60	0.75
D	20.70	20.90	21.30
D1	15.92	16.22	16.52
D2	1.00	1.20	1.35
E	15.50	15.80	16.10
E1	13.00	13.30	13.60
E2	4.80	5.00	5.20
E3	2.30	2.50	2.70
e	2.54 BSC		
e1	5.08 BSC		

Dimension unit: [mm]			
Symbol	Min	Nom	Max
L	19.62	19.92	20.22
L1	-	-	4.30
ϕP	3.40	3.60	3.80
$\phi P1$	-	-	7.30
Q	5.40	5.80	6.20
S	6.20 BSC		

Recommended Solder Pad Layout

Note: All dimensions are in mm

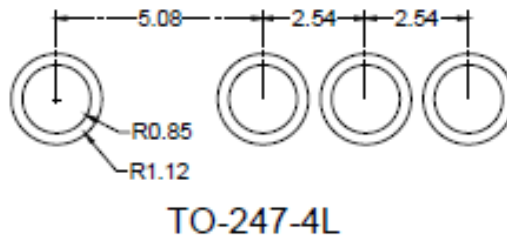

Ordering Information

Part number	AMS1200075M-ASATH
Package	TO-247-4L
Unit quantity	300 EA
Packing type	Tube

Important Notices – Read Carefully

Before you use our products, you are requested to carefully read this document and fully understand its contents. Sanan Semiconductor Co., Ltd. shall not be in any way responsible or liable for failure, malfunction or accident arising from the use of Sanan's products.

Sanan Semiconductor Datasheets are subject to change. Information presented in this document is from the characterization of engineering lots. Sanan Semiconductor Co., Ltd reserves the right to change limits, test conditions, and dimensions without notice. Information contained in this document are typical values and shall in no event be regarded as a guarantee of characteristics. With respect to any information regarding the application of the product, Sanan hereby disclaims all warranties and liabilities of any kind. The information in this document is exclusively for trained technical staff. It is the responsibility of the customer's technical department to decide the suitability of the product in the customer's application and Sanan Semiconductor Co., Ltd assumes no responsibility or liability whatsoever for the use of the information contained in this document.

In case there is any clause in this document or in any other documents which is contradictory to this clause, this clause shall prevail. This clause shall survive after termination of this document.

Warning

Due to technical requirements, Sanan's products may contain dangerous substances. For detailed information about the substance(s), please contact the Sanan office. Sanan Semiconductor Co., Ltd bears no responsibility for any damage whatsoever due to the substance(s) used in Sanan's products.

Contact info

Website: <https://www.sanan-semiconductor.com/>
<https://www.sanan-semiconductor.com/en>